

AMANO

COMPUTERIZED TIME RECORDERS

MJR-7000 SERIES

PROGRAM/OPERATION MANUAL



AMANO MJR-7000 COMPUTERIZED TIME RECORDER

TABLE OF CONTENTS

I.	Location of Parts	2
II.	Initial Preparation	3-5
III.	Replacement of Ribbon Cartridge	6
IV.	Summary of Program and Operation Codes	7
V.	Program Manual:	
	a) Section 1 - Calendar and Clock	8
	b) Section 2 - Basic Programming	8-9
	c) Section 3 - Signal Programming	10-13
	d) Section 4 - Work Schedule Programming	14-21
VI.	Operation Manual:	
	a) Program Print Out	22
	b) Individual Data Correction	23-25
	c) Individual Data Clear	26
	d) Attendance Report (Current Pay Period)	27
	e) Attendance Report (Previous Pay Period)	28
VII.	Error Code List	29-31

Section 1 – Location of Parts

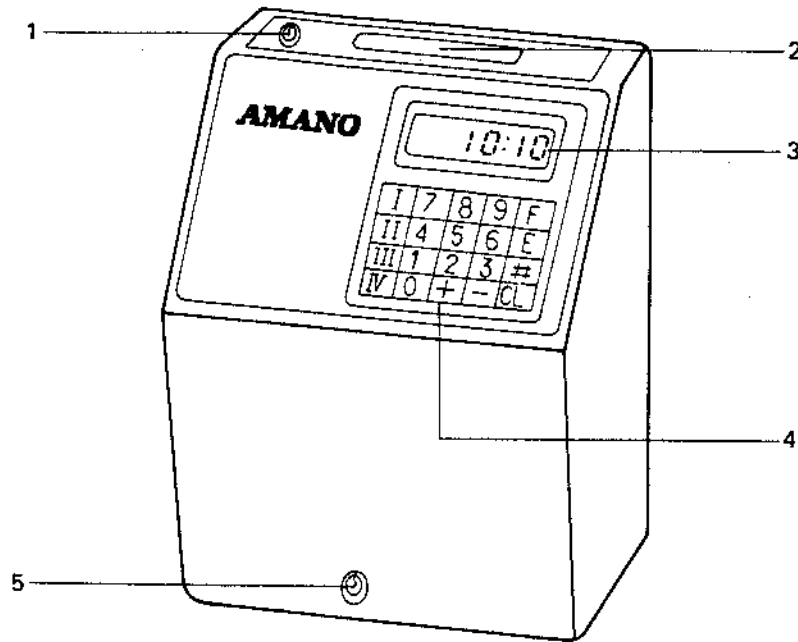

1. Key switch 2 positions : "NORMAL" mode for IN/OUT punch.
"FUNCTION" mode for programming, data correction, etc.
2. Card pocket
3. Display Displays date, day of week, time, AM/PM, program functions, etc.
4. Keyboard Functions listed in chart below.
5. Cabinet lock

KEYBOARD

KEY	NAME	FUNCTION
I	Program storage key	Enters programmed data into program storage.
II - IV		No function
0 - 9	Ten keys	Input of data
+ -	Plus/minus keys	Add and subtract data for corrections.
#	Number key	Advances parameters within function.
CL	Clear key	Clears miskeyed data before E key is pressed.
E	Enter key	Registers keyed-in data to memory & advances to next function.
F	Function key	Selects desired function number.

Section 2 – Preparation

1. Installation

- (a) Power : AC 120/220/240V±10%
- (b) Ambient Condition : -10°C ~ 40°C (14°F ~ 104°F)
- (c) Humidity : 20% ~ 90% (No water condensation)
- (d) Dimension : 340 mm (13-1/2")H x 240 mm (9-1/2")W x 200 mm (8")D
- (e) Weight : 8.5 kg (19 lbs)
- (f) Avoid direct sunlight and dusty area.
- (g) May either be table top or wall mounted.

For wall mounting:

- (1) Unlock and remove the cover case.
Remove 2 screws (A) that affix the back plate to the body, and push the back plate down.
- (2) Knock out 3 holes (B) and (C) on the back plate. Drive 1 wood screw to the wall and hang the back plate by the center hole (B). After ascertaining that back plate is level, affix the 3 wood screws and firmly secure the back plate on the wall.

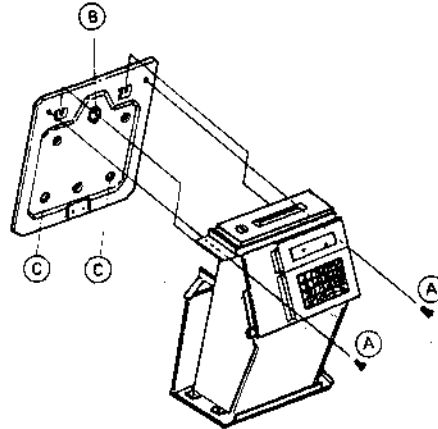

- (3) Install the body on the back plate. Fit the hanger lips of the body frame into the grooves of the back plate. Then install 2 screws to firmly affix the body onto the back plate.

2. Initial Preparation

- A. Unlock and remove cover case with case opening key #700, peel off plastic seal on the display and keyboard.
Remove the white packing material on the ribbon cartridge.
- B. Plug in battery connector (3P, blue and red wires) to CN-2, located at lower right, outside of frame, on the main Printed Circuit Board (JCU-1A). For full power reserve battery, (option: 200 imprints for IN/OUT or 4 hours display during power failure) plug in connector (4P, blue and red wires) to CN-11 on brown colored Printed Circuit Board (JPR-1A), located on right hand-side of frame, under keyboard.
- C. Slide the cover case back on and lock it.
- D. Plug in A. C. power outlet. The printer section will move back and forth several times and the display may show an error code such as 8-80. To reset this error code 8-80, put case opening key #700 into function key slot, located at top leftside of card pocket, and turn it to "FUNCTION" mode, (in the direction of the arrow) then press **CL** key.
- E. Set the key switch at the top to the "FUNCTION" mode. (Turn to the right.) The display will go blank.
- F. To clear the data in the memory, follow the procedure below:
Press **3** **2** **E** then **6** **4** **E**.
Memory is now clear and ready for programming.
- G. Turn the key switch to "NORMAL".

3. To set time

A. Set key switch to "FUNCTION" mode. Display will go blank.



B. Press **1** **0** **E** keys.



C. Key in the year (1990). Press **#** key.



D. Key in the month and date (May 8). Press **#** key.



E. Key in the hour and minute using military time (2:34PM). Press **E** key. Display will go blank.

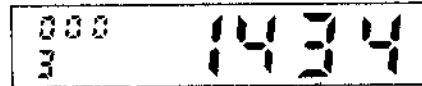

Note: When **E** key is pressed, the clock begins from 00 seconds of the set minute.

SPECIAL MEMO FOR PROGRAMMING

1. All time data must be entered in military time (0–23 hours).

2. How to clear or cancel data.

A. Calendar and clock data may be changed but not cleared or cancelled.

B. To clear data in memory, press the following keys:

3 **0** **E** then **8** **8** **E** to clear all employees' data

3 **1** **E** then **9** **9** **E** to clear programmed data

3 **2** **E** then **6** **4** **E** to clear both employee and programmed data

C. To clear data on the display:

1. To clear simple key-in errors before pressing **E** key (before entering into memory) press **CL** key.

2. To clear data on display that is in memory, press keys as follows:

When there is only one parameter within the function to be cleared: **0** **E**

When there are three parameters within the function to be cleared: **0** **#** **0** **#**

0 **E**

3. To change the data on the display:

When there is only one parameter within the function to be changed:

NEW DATA **E**

When there are three parameters within the function to be changed:

NEW DATA **#** **NEW DATA** **#** **NEW DATA** **E**

4. When data is cleared or new data is entered, be sure to press **I** key before turning the key switch to "NORMAL".

D. Programming of days (Monday through Sunday) will be in numeric code as follows:

- 1 Monday
- 2 Tuesday
- 3 Wednesday
- 4 Thursday
- 5 Friday
- 6 Saturday
- 7 Sunday
- 8 Monday through Friday
- 9 Monday through Sunday

E. There are four programming areas for the MJR-7000 Series:

- 1. Clock programming area – Function no. 000.
- 2. Basic programming area – Function no. 001–019.
- 3. Signal programming area (optional) – Function no. 020-050.
- 4. Work shift programming area – Function no. 100–149.

3. Types of cards

A. Time Card – Records IN/OUT time, accumulated hours, data corrections, and gross pay calculations.

B. Lock-out Release Card – Used in conjunction with time cards. Allows employee to punch during lock-out time zone.

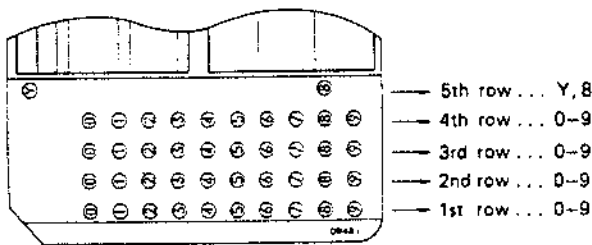

ROW	APPLICATION
1	Machine no. and 1st digit of card no.
2	2nd digit of card no.
3	3rd digit of card no.
4	0 must always be punched.
5	Y & 8 must always be punched.

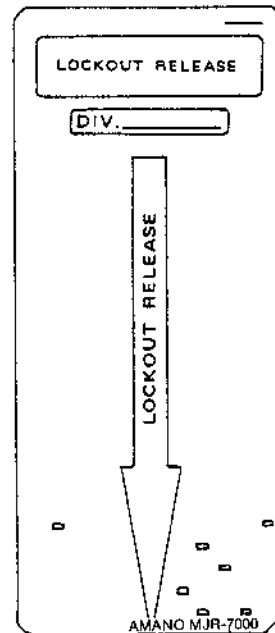

The time card has five rows of numbers for perforation on the bottom front side. Cards may be purchased pre-punched or prepared, manually with the hand puncher provided. Refer to the chart above preparation of unperforated cards.

Section 3 – Replacement of Ribbon Cartridge

When printing becomes too light, replace the ribbon cartridge in the following manner:

1. Remove the white thumb screw (1) at the lower right of the Keyboard Panel.
2. Lift up the Keyboard Panel (2). Rotate the black gear (3) located on right hand-side of the frame, until ribbon cartridge moves to the right side slightly.
3. To remove the ribbon cartridge, raise the end up and lift it out.
4. Place the new cartridge in cartridge casing in slanted position, and make sure the protrusions on both ends snap into position.
5. Slowly lower the front portion of cartridge while turning the knob on the cartridge. Insure that the ribbon is in the ribbon guide.
6. To check for proper printing, insert a card, and print out programmed data.

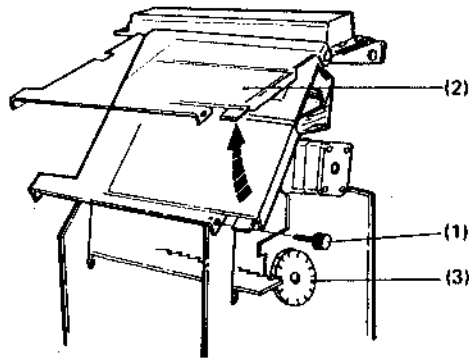

MJR-7000 SUMMARY OF PROGRAMMING/OPERATION CODES

PROGRAMMING AREAS

- | | | |
|---|---|---|
| 1 | 0 | E |
|---|---|---|

 = Clock and Calendar Programming Area
- | | | |
|---|---|---|
| 2 | 0 | E |
|---|---|---|

 = Basic Programming Area
- | | | |
|---|---|---|
| 2 | 1 | E |
|---|---|---|

 = Signal Programming Area (OPTIONAL signal kit must be installed to send signals)
- | | | |
|---|---|---|
| 2 | 2 | E |
|---|---|---|

 = Work Schedule Programming Area

OPERATION AREAS

- | | | |
|---|---|---|
| 2 | 3 | E |
|---|---|---|

 = Program Print Out
- | | |
|---|---|
| 1 | E |
|---|---|

 = Individual Data Correction (Current Pay Period)
- | | |
|---|---|
| 5 | E |
|---|---|

 = Individual Data Clear
- | | | |
|---|---|---|
| 4 | 0 | E |
|---|---|---|

 = Attendance Report (Current Pay Period)
- | | | |
|---|---|---|
| 4 | 1 | E |
|---|---|---|

 = Attendance Report (Previous Pay Period)

MJR-7000 PROGRAM MANUAL

SECTION 1: CLOCK AND CALENDAR PROGRAMMING AREA
TO ENTER PROGRAM AREA - TURN THE KEY AND PRESS 1 0 E

PROGRAM ADDRESS NO.	SAMPLE DATA	PROGRAM CODES AND EXAMPLES	PROGRAM DATA
000 1	1 9 9 0 #	Calendar year	#
2	4 3 0 #	Month and Date	#
3	1 5 2 8 E	Hour and Minute (24 hour format)	E

SECTION 2: BASIC PROGRAMMING AREA
TO ENTER PROGRAM AREA - TURN THE KEY AND PRESS 2 0 E

PROGRAM ADDRESS NO.	SAMPLE DATA	PROGRAM CODES AND EXAMPLES	PROGRAM DATA
001 1	4 0 1 #	Date Daylight Saving Time Begins (Ex: April 1)	#
2	1 0 2 8 E	Date Daylight Saving Time Ends (Ex: October 28)	E
002 1	0 E	Machine Number 0 - 9 : Time Cards No. 000-099, enter 0 Time Cards No. 100-199, enter 1 Time Cards No. 200-299, enter 2 Time Cards No. 300-399, enter 3 : : : : Time Cards No. 900-999, enter 9	E
003 1	1 #	Imprint of hours for IN/OUT times: 0 = 0-23 Hour format (military time) 1 = 1-12/1-12 AM/PM Hours	#
2	0 #	Imprint of accumulated minutes: 0 = Regular minutes (00-59) 1 = 1/100 of hour (00-98)	#
3	0 E	Printing of Day of week: 0 : English days (MO...SA, SU) 1 : Day numbers (1...6, 7) 2 : French days (LU...SA, DI)	E

(Continued)

PROGRAM ADDRESS NO.	SAMPLE DATA	PROGRAM CODES AND EXAMPLES	PROGRAM DATA
004 1	1 0 1 E	Month and Date of Holiday (Jan. 1st)	E
005 1	2 1 9 E	Month and Date of Holiday (Feb. 19th)	E
006 1	7 0 4 E	Month and Date of Holiday (July 4th)	E
007 1	9 0 3 E	Month and Date of Holiday (Sep. 3rd)	E
008 1	1 1 2 2 E	Month and Date of Holiday (Nov. 22nd)	E
009 1	1 1 2 3 E	Month and Date of Holiday (Nov. 23rd)	E
010 1	1 2 2 5 E	Month and Date of Holiday (Dec. 25th)	E
011 1	0 E	Month and Date of Holiday	E
012 1	0 E	Month and Date of Holiday	E
013 1	0 E	Month and Date of Holiday	E
014 1	0 E	Month and Date of Holiday	E
015 1	0 E	Month and Date of Holiday	E
016 1	0 E	Month and Date of Holiday	E
017 1	0 E	Month and Date of Holiday	E
018 1	0 E	Month and Date of Holiday	E
019 1	0 E	Month and Date of Holiday	E

Addresses 004-019 are programmable for UP to 16 HOLIDAYS

Holidays worked can be sorted into regular hours or overtime hours in section 3 (22E) address 105.

IMPORTANT: UPON COMPLETION OF THE BASIC PROGRAMMING AREA, BE SURE TO PRESS THE I KEY TO SAVE THE DATA INTO MEMORY.

SECTION 3: SIGNAL PROGRAMMING AREA (OPTIONAL)
TO ENTER PROGRAM AREA - TURN THE KEY AND PRESS 2 1 E

PROGRAM ADDRESS NO.	SAMPLE DATA	PROGRAM CODES AND EXAMPLES	PROGRAM DATA
020 1	1 0 E	Signal duration in seconds (0-15) Note: If the signal is not used enter 0	E
021 1	8 #	Day Code Numbers: 1=Monday 6=Saturday 2=Tuesday 7=Sunday 3=Wednesday 8=Monday thru Friday 4=Thursday 9=Monday thru Sunday 5=Friday NOTE: If the signal applies for Mon, Wed and Fri, key in code numbers 1,3, and 5. (The days selected will appear on the display)	#
2	7 5 5 E	Signal Time (HHMM)	E
022 1	5 #	Day Code Number (1-9)	#
2	8 0 0 E	Signal Time (HHMM)	E
023 1	5 #	Day Code Number (1-9)	#
2	1 2 0 0 E	Signal Time (HHMM)	E
024 1	5 #	Day Code Number (1-9)	#
2	1 2 3 0 E	Signal Time (HHMM)	E
025 1	#	Day Code Number (1-9)	#
2	E	Signal Time (HHMM)	E
026 1	#	Day Code Number (1-9)	#
2	E	Signal Time (HHMM)	E

(Continued)

PROGRAM ADDRESS NO.		SAMPLE DATA			PROGRAM CODES AND EXAMPLES	PROGRAM DATA		
027	1			#	Day Code Number (1-9)			#
	2			E	Signal Time (HHMM)			E
028	1			#	Day Code Number (1-9)			#
	2			E	Signal Time (HHMM)			E
029	1			#	Day Code Number (1-9)			#
	2			E	Signal Time (HHMM)			E
030	1			#	Day Code Number (1-9)			#
	2			E	Signal Time (HHMM)			E
031	1			#	Day Code Number (1-9)			#
	2			E	Signal Time (HHMM)			E
032	1			#	Day Code Number (1-9)			#
	2			E	Signal Time (HHMM)			E
033	1			#	Day Code Number (1-9)			#
	2			E	Signal Time (HHMM)			E
034	1			#	Day Code Number (1-9)			#
	2			E	Signal Time (HHMM)			E
035	1			#	Day Code Number (1-9)			#
	2			E	Signal Time (HHMM)			E
036	1			#	Day Code Number (1-9)			#
	2			E	Signal Time (HHMM)			E

(Continued)

PROGRAM ADDRESS NO.		SAMPLE DATA				PROGRAM CODES AND EXAMPLES				PROGRAM DATA			
037	1				#	Day Code Number (1-9)							#
	2				E	Signal Time (HHMM)							E
038	1				#	Day Code Number (1-9)							#
	2				E	Signal Time (HHMM)							E
039	1				#	Day Code Number (1-9)							#
	2				E	Signal Time (HHMM)							E
040	1				#	Day Code Number (1-9)							#
	2				E	Signal Time (HHMM)							E
041	1				#	Day Code Number (1-9)							#
	2				E	Signal Time (HHMM)							E
042	1				#	Day Code Number (1-9)							#
	2				E	Signal Time (HHMM)							E
043	1				#	Day Code Number (1-9)							#
	2				E	Signal Time (HHMM)							E
044	1				#	Day Code Number (1-9)							#
	2				E	Signal Time (HHMM)							E
045	1				#	Day Code Number (1-9)							#
	2				E	Signal Time (HHMM)							E
046	1				#	Day Code Number (1-9)							#
	2				E	Signal Time (HHMM)							E

(Continued)

PROGRAM ADDRESS NO.	SAMPLE DATA	PROGRAM CODES AND EXAMPLES	PROGRAM DATA
047 1	#	Day Code Number (1-9)	#
2	E	Signal Time (HHMM)	E
048 1	#	Day Code Number (1-9)	#
2	E	Signal Time (HHMM)	E
049 1	#	Day Code Number (1-9)	#
2	E	Signal Time (HHMM)	E
050 1	#	Day Code Number (1-9)	#
2	E	Signal Time (HHMM)	E

IMPORTANT: UPON COMPLETION OF THE SIGNAL PROGRAMMING AREA, BE SURE TO PRESS THE I KEY TO SAVE THE DATA INTO MEMORY.

**SECTION 4: WORK SCHEDULE PROGRAMMING AREA
TO ENTER PROGRAM AREA - TURN THE KEY AND PRESS**

2 2 E

PROGRAM ADDRESS NO.	SAMPLE DATA	PROGRAM CODES AND EXAMPLES	PROGRAM DATA
100 1	1 #	<p>Pay Period Type:</p> <p>0= WEEKLY (Front side only)</p> <p>1= WEEKLY (Use both sides of card - Programmed week is front side)</p> <p>2= WEEKLY (Use both sides of card - Programmed week is back side)</p> <p>3= BIWEEKLY (Pay ending comes next week)</p> <p>4= BIWEEKLY (Pay ending comes this week)</p> <p>5= SEMIMONTHLY</p> <p>6= MONTHLY</p>	#
Example 2	(5 #)		
2	7 E	<p>For Weekly or Biweekly Pay Period - Enter Pay Ending DAY and press E</p> <p>1= Monday 5= Friday</p> <p>2= Tuesday 6= Saturday</p> <p>3= Wednesday 7= Sunday</p> <p>4= Thursday</p> <p>For Semimonthly or Monthly Periods - Enter the earlier of the two pay ending DATES and press #.</p> <p>EX: If the pay period ends on the 10th and 25th enter 1 0 #.</p> <p><u>Exception:</u> If the pay period ends on the 15th and at the end of the month enter 3 1 #.</p>	E
	(3 1 #)		(#)
3	(7 E)	<p>For semimonthly and monthly only: Enter the work week ending day to be used for overtime calculation.</p>	(E)
101 1	8 0 0 #	<p>Maximum daily regular hours. (Hours worked exceeding this amount will be sorted to Overtime Category A).</p>	#
2	1 2 0 0 E	<p>Maximum daily hours for overtime A. (Hours worked exceeding this amount will be sorted to Overtime Category B).</p> <p>NOTE: If daily overtime is not used, enter 0.</p>	E

(Continued)

PROGRAM ADDRESS NO.		SAMPLE DATA				PROGRAM CODES AND EXAMPLES	PROGRAM DATA																									
102	1	4	0	0	0	#	Maximum weekly regular hours. (Hours worked exceeding this amount will be sorted to Overtime Category A).				#																					
	2	4	8	0	0	E	Maximum weekly hours for overtime A. (Hours worked exceeding this amount will be sorted to Overtime Category B). NOTE: If weekly overtime is not used, enter 0.				E																					
103	1			1	5	#	Rounding Unit for IN and OUT times				#																					
	2				8	#	Rounding break point for IN times.				#																					
	3			1	0	E	Rounding break point for OUT times.				E																					
104	1			1	5	E	Paid Break (Using "#" key) (00 - 60 minutes)																									
105	1				6	#	First Non-Working Day (EX: Saturday)				#																					
	2				7	#	Second Non-Working Day (EX: Sunday)				#																					
	3				0	E	Use the following chart to select what category the hours worked on non-working days and holidays will be sorted to:				E																					
							<table border="1"> <thead> <tr> <th>Data Code#</th> <th>Weekly Non-Working Days</th> <th>National Holidays</th> </tr> </thead> <tbody> <tr> <td>0</td> <td>OT. A</td> <td>OT. B</td> </tr> <tr> <td>1</td> <td>OT. A</td> <td>OT. A</td> </tr> <tr> <td>2</td> <td>OT. B</td> <td>OT. B</td> </tr> <tr> <td>3</td> <td>Reg.</td> <td>Reg.</td> </tr> <tr> <td>4</td> <td>Reg.</td> <td>OT. A</td> </tr> <tr> <td>5</td> <td>Reg.</td> <td>OT. B</td> </tr> </tbody> </table>					Data Code#	Weekly Non-Working Days	National Holidays	0	OT. A	OT. B	1	OT. A	OT. A	2	OT. B	OT. B	3	Reg.	Reg.	4	Reg.	OT. A	5	Reg.	OT. B
Data Code#	Weekly Non-Working Days	National Holidays																														
0	OT. A	OT. B																														
1	OT. A	OT. A																														
2	OT. B	OT. B																														
3	Reg.	Reg.																														
4	Reg.	OT. A																														
5	Reg.	OT. B																														

(Continued)

PROGRAM ADDRESS NO.	SAMPLE DATA	PROGRAM CODES AND EXAMPLES	PROGRAM DATA
106 1	0 #	Day Change Override Code - 0= Allows employees to work thru day change time up to <u>12H 59M</u> from 1st IN punch. 1= Does not allow employees to work thru day change time. (Out punch crossing day change time will be considered a new day.) 2= Allows employees to work thru day change time up to <u>17H-59M</u> from 1st IN punch.	#
2	1 0 0 E	Day Change Time (EX: 1am)	E
107		Automatic Break Deduction by number of daily worked hours:	
1	6 0 0 #	Daily worked hours	#
2	3 0 E	Amount of time to be deducted	E
108		Automatic Break Deduction by number of daily worked hours:	
1	1 0 0 0 #	Daily worked hours	#
2	3 0 E	Amount of time to be deducted	E
109 1	0 #	Day Change Time <u>BEFORE/AFTER</u> Midnight 0= After Midnight 1= Before Midnight NOTE: If day change time is programmed before midnight, set the pay ending day or date and National Holiday for the <u>ACTUAL</u> day or date.	
2	1 5 #	Break Net Rounding Unit (0-60)	#
3	8 E	Break Net Rounding Break Point (0-60)	E

NOTE: BREAK TIME DEDUCTIONS PROGRAMMED IN ADDRESS 107-108 ARE CUMULATIVE

(Continued)

PROGRAM ADDRESS NO.	SAMPLE DATA	PROGRAM CODES AND EXAMPLES	PROGRAM DATA
110	1	The following applies to addresses 110-149: Step 1: Select Code Number Step 2: Time zone beginning Step 3: Time zone ending	#
	2		#
	3		E
111	1	<u>CODE NUMBERS:</u> 0 = Not applicable 1 = 1st IN punch revision time zone 2 = OUT punch revision time zone 3 = IN punch revision time zone (All IN punches except 1st IN punch) 4 = 1st IN punch lock out time zone 5 = OUT punch lock out time zone 6 = IN punch lock out time zone 7 = Fixed break time zone (unpaid)	#
	2		#
	3		E
112	1	NOTE: Code 7, fixed break time zone cannot be programmed at the same time as the automatic flexible break deductions in address NO.'s 107 and 108.	#
	2		#
	3		E
113	1		#
	2		#
	3		E
114	1		#
	2		#
	3		E
115	1		#
	2		#
	3		E
116	1	Ex: Code 1 - 1st IN Revision ---->	#
	2	1st IN punches between 8:30am and 9:00am will be calculated from 9:00am.	#
	3		E
117	1	Ex: Code 2 - OUT Revision <----	#
	2	All OUT punches between 5:00pm and 5:15pm will stop calculating at 5:00pm.	#
	3		E

(Continued)

PROGRAM ADDRESS NO.		SAMPLE DATA				PROGRAM CODES AND EXAMPLES	PROGRAM DATA			
118	1			3	#	Ex: Code 3 - IN Revision ---->				#
	2	1	2	3	1 #	All IN punches except the 1st IN punch between 12:31pm and 12:45pm will be calculated from 12:45.				#
	3	1	2	4	5 E					E
119	1			4	#		Ex: Code 4 - 1st IN Lock Out			
	2		5	0	0 #	1st IN punches between 5:00am and 8:29am will not be accepted. The clock will reject employee's card.				#
	3		8	2	9 E					E
120	1			5	#	Ex: Code 5 - OUT Lock Out				#
	2	1	7	1	6 #	All OUT punches between 5:16pm and 9:00pm will not be accepted. The clock will reject employee's card				#
	3	2	1	0	0 E					E
121	1			6	#	Ex: Code 6 - IN Lock Out				#
	2	1	3	0	1 #	All IN punches except the 1st IN punch between 1:00pm and 1:30pm will not be accepted.				#
	3	1	3	3	0 E					E
122	1			7	#	Ex: Code 7 - Fixed Break				#
	2	1	2	0	0 #	30 minutes between 12pm and 12:30pm will be deducted regardless if employees punches for break.				#
	3	1	2	3	0 E					E
123	1				#	<div style="border: 1px solid black; padding: 2px; display: inline-block;">SPECIAL MEMO FOR PROGRAMMING</div>				#
	2				#					#
	3				E					E
124	1				#	1) Day change time cannot be programmed within a time zone. 2) Programmed starting and ending times are INCLUSIVE for the time zone. 3) Time zones for the same code numbers cannot be overlapped. 4) IN or OUT revisions override IN/OUT rounding.				#
	2				#					#
	3				E					E
125	1				#					#
	2				#					#
	3				E					E

(Continued)

PROGRAM ADDRESS NO.	SAMPLE DATA	PROGRAM CODES AND EXAMPLES	PROGRAM DATA
126	1	5) Lock Out zones override revision zones. 6) The 1st IN punch zone overrides the fixed break time zone.	#
	2		#
	3		E
127	1		#
	2		#
	3		E
128	1	#	
	2	#	
	3	E	
129	1	#	
	2	#	
	3	E	
130	1	#	
	2	#	
	3	E	
131	1	#	
	2	#	
	3	E	
132	1	#	
	2	#	
	3	E	
133	1	#	
	2	#	
	3	E	

(Continued)

PROGRAM ADDRESS NO.		SAMPLE DATA			PROGRAM CODES AND EXAMPLES	PROGRAM DATA		
134	1			#			#	
	2			#			#	
	3			E			E	
135	1			#			#	
	2			#			#	
	3			E			E	
136	1			#			#	
	2			#			#	
	3			E			E	
137	1			#			#	
	2			#			#	
	3			E			E	
138	1			#			#	
	2			#			#	
	3			E			E	
139	1			#			#	
	2			#			#	
	3			E			E	
140	1			#			#	
	2			#			#	
	3			E			E	
141	1			#			#	
	2			#			#	
	3			E			E	

(Continued)

PROGRAM ADDRESS NO.	SAMPLE DATA	PROGRAM CODES AND EXAMPLES	PROGRAM DATA
142	1		#
	2		#
	3		E
143	1		#
	2		#
	3		E
144	1		#
	2		#
	3		E
145	1		#
	2		#
	3		E
146	1		#
	2		#
	3		E
147	1		#
	2		#
	3		E
148	1		#
	2		#
	3		E
149	1		#
	2		#
	3		E

**IMPORTANT: UPON COMPLETION OF THE WORK SCHEDULE PROGRAMMING AREA,
BE SURE TO PRESS THE I KEY TO SAVE THE DATA INTO MEMORY.**

MJR-7000 OPERATION MANUAL

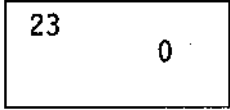
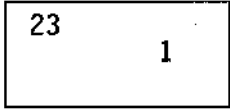
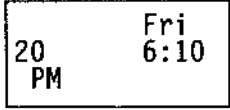
PROGRAM PRINT OUT - - To PRINT ALL PROGRAM DATA		
STEP	OPERATION	EXAMPLES OF DISPLAY
1	Turn key switch to "FUNCTION" mode. The display will go blank.	
2	Press <input type="text" value="2"/> <input type="text" value="3"/> <input type="text" value="E"/> keys.	
3	Insert program check card, when finished printing turn card over and print on back side.	
6	Remove card and turn key switch back to normal mode.	

**INDIVIDUAL DATA CORRECTION -
- TO MAKE CORRECTIONS ON INDIVIDUAL EMPLOYEE'S TIME CARDS**

STEP	OPERATION	EXAMPLES OF DISPLAY						
1	Turn key switch to "FUNCTION" mode. The display will go blank.	<div style="border: 1px solid black; width: 100px; height: 40px; margin: 0 auto;"></div>						
2	Press 1 E keys.	<div style="border: 1px solid black; width: 100px; height: 40px; display: flex; align-items: center; justify-content: center;"> 1 </div>						
3	a) Insert time card to be corrected.	<div style="border: 1px solid black; width: 100px; height: 40px; display: flex; align-items: center; justify-content: center;"> 1 </div>						
	b) Remove card from pocket. The amount of daily worked hours will be displayed.	<div style="border: 1px solid black; width: 100px; height: 40px; display: flex; align-items: center; justify-content: center;"> 1 8:45 </div>						
4	Press E key until the desired code appears on display: <table border="1" style="width: 100%; margin-top: 10px;"> <thead> <tr> <th style="width: 10%;">CODE NO.</th> <th>DESCRIPTION</th> </tr> </thead> <tbody> <tr> <td style="text-align: center;">1</td> <td>DAILY NET HOURS - to adjust NET hours for the current day. {Affects codes #3,4,&5 based on DAILY OVERTIME calculation rule}</td> </tr> <tr> <td style="text-align: center;">2</td> <td>WEEKLY NET HOURS - to adjust NET hours for the current week. {Affects codes #3,4,&5 based on WEEKLY OVERTIME calculation rule}</td> </tr> </tbody> </table>	CODE NO.	DESCRIPTION	1	DAILY NET HOURS - to adjust NET hours for the current day. {Affects codes #3,4,&5 based on DAILY OVERTIME calculation rule}	2	WEEKLY NET HOURS - to adjust NET hours for the current week. {Affects codes #3,4,&5 based on WEEKLY OVERTIME calculation rule}	<div style="border: 1px solid black; width: 100px; height: 40px; display: flex; align-items: center; justify-content: center; margin-top: 10px;"> 1 8:45 </div> <div style="border: 1px solid black; width: 100px; height: 40px; display: flex; align-items: center; justify-content: center; margin-top: 10px;"> 2 44:45 </div>
CODE NO.	DESCRIPTION							
1	DAILY NET HOURS - to adjust NET hours for the current day. {Affects codes #3,4,&5 based on DAILY OVERTIME calculation rule}							
2	WEEKLY NET HOURS - to adjust NET hours for the current week. {Affects codes #3,4,&5 based on WEEKLY OVERTIME calculation rule}							

(Continued)

**INDIVIDUAL DATA CORRECTION -
- To MAKE CORRECTIONS ON INDIVIDUAL EMPLOYEE'S TIME CARDS**

STEP	OPERATION	EXAMPLES OF DISPLAY														
	<table border="1"><thead><tr><th data-bbox="370 499 451 575">CODE NO.</th><th data-bbox="451 499 922 575">DESCRIPTION</th></tr></thead><tbody><tr><td data-bbox="370 575 451 743">3</td><td data-bbox="451 575 922 743">REGULAR HOURS - to adjust ACCUMULATED REGULAR hours for the current pay period. {Does not affect any other codes}</td></tr><tr><td data-bbox="370 743 451 890">4</td><td data-bbox="451 743 922 890">OVERTIME CATEGORY A HOURS - to adjust accumulated hours sorted to Overtime A. {Does not affect any other codes}</td></tr><tr><td data-bbox="370 890 451 1058">5</td><td data-bbox="451 890 922 1058">OVERTIME CATEGORY B HOURS - to adjust accumulated hours sorted to Overtime B. {Does not affect any other codes}</td></tr></tbody></table>	CODE NO.	DESCRIPTION	3	REGULAR HOURS - to adjust ACCUMULATED REGULAR hours for the current pay period. {Does not affect any other codes}	4	OVERTIME CATEGORY A HOURS - to adjust accumulated hours sorted to Overtime A. {Does not affect any other codes}	5	OVERTIME CATEGORY B HOURS - to adjust accumulated hours sorted to Overtime B. {Does not affect any other codes}	<table border="1"><tbody><tr><td data-bbox="1036 604 1084 659">3</td><td data-bbox="1117 638 1208 659">40:00</td></tr><tr><td data-bbox="1036 772 1084 827">4</td><td data-bbox="1117 806 1208 827">3:45</td></tr><tr><td data-bbox="1036 940 1084 995">5</td><td data-bbox="1117 953 1208 974">1:00</td></tr></tbody></table>	3	40:00	4	3:45	5	1:00
CODE NO.	DESCRIPTION															
3	REGULAR HOURS - to adjust ACCUMULATED REGULAR hours for the current pay period. {Does not affect any other codes}															
4	OVERTIME CATEGORY A HOURS - to adjust accumulated hours sorted to Overtime A. {Does not affect any other codes}															
5	OVERTIME CATEGORY B HOURS - to adjust accumulated hours sorted to Overtime B. {Does not affect any other codes}															
3	40:00															
4	3:45															
5	1:00															
5	<p>Key in the number of hours to be added or subtracted and then press <input type="checkbox"/>+ or <input type="checkbox"/>- , followed by <input type="checkbox"/>E key.</p> <p>Example 1: Add 2 hours to Overtime A -Press <input type="checkbox"/>E until code no. 4 appears</p> <p>-Press <input type="checkbox"/>2 <input type="checkbox"/>0 <input type="checkbox"/>0 keys</p> <p>-Press <input type="checkbox"/>+ key {2 hours are added to the previous amount displayed}</p>	<table border="1"><tbody><tr><td data-bbox="1036 1268 1084 1323">4</td><td data-bbox="1117 1289 1208 1310">4:45</td></tr><tr><td data-bbox="1036 1436 1084 1491">4</td><td data-bbox="1117 1457 1208 1478">2:00</td></tr><tr><td data-bbox="1036 1596 1084 1650">4</td><td data-bbox="1117 1617 1208 1638">6:45</td></tr></tbody></table>	4	4:45	4	2:00	4	6:45								
4	4:45															
4	2:00															
4	6:45															



(Continued)

INDIVIDUAL DATA CORRECTION - - TO MAKE CORRECTIONS ON INDIVIDUAL EMPLOYEE'S TIME CARDS				
STEP	OPERATION	EXAMPLES OF DISPLAY		
	-Press <input type="checkbox"/> E key to advance to the next code.	<table border="1"><tr><td>5</td><td>1:00</td></tr></table>	5	1:00
5	1:00			
6	Insert the employee's time card for the correction to print on the card	<table border="1"><tr><td>5</td><td>1:00</td></tr></table>	5	1:00
5	1:00			
7	Turn key switch to "NORMAL" mode.	<table border="1"><tr><td>20 PM</td><td>Fri 6:17</td></tr></table>	20 PM	Fri 6:17
20 PM	Fri 6:17			

**INDIVIDUAL DATA CLEAR -
- TO CLEAR ALL DATA FOR AN INDIVIDUAL EMPLOYEE**

STEP	OPERATION	EXAMPLES OF DISPLAY
1	Turn key switch to "FUNCTION" mode. The display will go blank.	<div style="border: 1px solid black; width: 100px; height: 40px; margin: 0 auto;"></div>
2	Press 5 E keys.	<div style="border: 1px solid black; width: 100px; height: 40px; display: flex; align-items: center; justify-content: center;">5</div>
3	Insert employee time card to be cleared. (Card number appears on display.	<div style="border: 1px solid black; width: 100px; height: 40px; display: flex; align-items: center; justify-content: center;">072</div>
4	Press E key. Machine beeps, clears memory for that employee and automatically ejects time card.	<div style="border: 1px solid black; width: 100px; height: 40px; display: flex; align-items: center; justify-content: center;">072</div>
5	Remove card from pocket.	<div style="border: 1px solid black; width: 100px; height: 40px; display: flex; align-items: center; justify-content: center;">5</div>
6	Turn key switch to "NORMAL" mode.	<div style="border: 1px solid black; width: 100px; height: 40px; display: flex; align-items: center; justify-content: center;"> <div style="text-align: right; margin-right: 20px;">20 PM</div> <div style="text-align: left;">Fri 6:25</div> </div>

**ATTENDANCE REPORT FOR THE CURRENT PAY PERIOD -
 - TO PRINT SUMMARIES OF ALL EMPLOYEE'S HOURS ON A REPORT CARD**

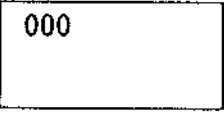
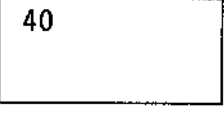
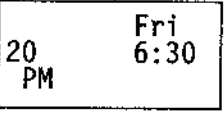
STEP	OPERATION	EXAMPLES OF DISPLAY
1	Turn key switch to "FUNCTION" mode. The display will go blank.	
2	Press <input type="text" value="4"/> <input type="text" value="0"/> <input type="text" value="E"/> keys	
3	Insert attendance report card. (display shows card number being printed.) Card will automatically eject when printing has stopped.	
4	Remove card from pocket.	
7	Turn key switch to "NORMAL" mode.	

**ATTENDANCE REPORT FOR THE PREVIOUS PAY PERIOD -
 - TO PRINT SUMMARIES OF ALL EMPLOYEE'S HOURS ON A REPORT CARD**

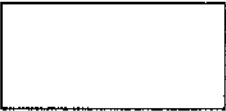
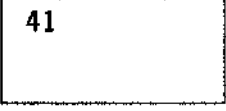
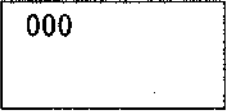
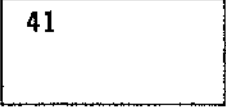
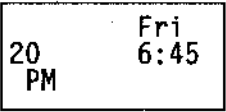
STEP	OPERATION	EXAMPLES OF DISPLAY
1	Turn key switch to "FUNCTION" mode. The display will go blank.	
2	Press <input type="text" value="4"/> <input type="text" value="1"/> <input type="text" value="E"/> keys	
3	Insert attendance report card. (display shows card number being printed.) Card will automatically eject when printing has stopped.	
4	Remove card from pocket.	
7	Turn key switch to "NORMAL" mode.	

MJR-7000 ERROR CODE LIST

ERROR CODE	REASON	SOLUTION
0 - 01	INSERTED TIME CARD FACING THE WRONG SIDE.	RE-INSERT TIME CARD FACING THE CORRECT SIDE.
0 - 08	AFTER ENTERING CORRECTION DATA, INSERTED WRONG CARD FOR CARD PRINTING.	INSERT CORRECT TIME CARD.
0 - 12	INSERTED TIME CARD DURING LOCK OUT PERIOD.	OVERRIDE LOCK OUT BY USING LOCK OUT RELEASE CARD, IF AUTHORIZED.
1 - 20	INCORRECT MACHINE NO. ON TIME CARD OR IN PROGRAMMED DATA.	CHECK PROGRAMMED DATA IN SECTION 20E, ADDRESS 002 AND TIME CARD NUMBER.
1 - 22	INSERTED INCORRECTLY CODED (PERFORATED) TIME CARD.	USE PROPERLY CODED TIME CARD.
1 - 30	IMPROPER TIME CARD. (TOO SHORT)	REISSUE PROPER SIZE, PROPERLY CODED, TIME CARD.

(CONTINUED)

ERROR CODE	REASON	SOLUTION
1 - 31	IMPROPER TIME CARD. (TOO LONG)	REISSUE PROPER SIZE, PROPERLY CODED, TIME CARD.
8 - 80 X	INCORRECT DATA PROGRAMMED.	CLEAR PROGRAM MEMORY OF APPLICABLE AREA AND REPROGRAM.
8 - 85 X	INDIVIDUAL DATA FILE READING ERROR.	TURN KEY SWITCH TO "FUNCTION" MODE. PRESS CL KEY TO CLEAR. RE-ENTER DATA AS NEEDED
8 - 88 X	CPU (MEMORY) DEFECT.	TURN KEY SWITCH TO "FUNCTION" MODE. PRESS CL KEY TO CLEAR.
9 - 50 X	INSERTED TIME CARD FOR PRINTING EARLIER THAN PREVIOUSLY PRINTED TIME.	PRESS CL KEY. MAKE SURE THE CLOCK IS SET TO THE CURRENT DATE AND TIME.
9 - 60 X	TEMPORARY DEFECT OF SOFTWARE CAUSED BY NOISE OR SURGE FROM OUTSIDE POWER SOURCE.	RESETS AUTOMATICALLY IN 3 SECONDS AFTER ERROR DISPLAY.

(CONTINUED)

ERROR CODE	REASON	SOLUTION
9 - 61 X	TEMPORARY DEFECT OF CPU CAUSED BY NOISE OR SURGE FROM OUTSIDE POWER SOURCE.	RESETS AUTOMATICALLY IN 3 SECONDS AFTER ERROR DISPLAY.
9 - 70 X	PROBLEM OF HARDWARE SUCH AS PRINTER TIMING IMPULSE, SENSOR, MOTOR, ETC.	CLEAR ENTRY BY CL KEY AND CLEAN SENSORS.
9 - 90 X	CARD READING FAILURE.	PRESS CL KEY AND CALL SERVICE.
9 - 91 X	CARD SENSOR LEVEL DEFECT.	PRESS CL KEY AND CALL SERVICE.



Central Time Clock

Since 1931

5-23 50th Avenue | Long Island City, NY 11101

P: 718.784.4900 F: 718-472-9491

www.centraltimeclock.com